



# Instruction Manual

## Karmel Baby

Model No. 2626, 2626EX







**GOLD MEDAL® PRODUCTS CO.**



10700 Medallion Drive, Cincinnati, Ohio 45241-4807 USA







# SAFETY PRECAUTIONS

	 <b>DANGER</b>
	<p>Machine must be properly grounded to prevent electrical shock to personnel. Failure to do so could result in serious injury, or death.                  DO NOT immerse any part of this equipment in water.                  DO NOT use excessive water when cleaning.                  Keep cord and plug off the ground and away from moisture.                  Always unplug the equipment before cleaning or servicing.                  Make sure all machine switches are in the OFF position before plugging the equipment into the receptacle.</p> <p style="text-align: right; font-size: small;">008_051514</p>

	 <b>DANGER</b>
	<p>Improper installation, adjustment, alteration, service, or maintenance can cause property damage, injury, or death. Any alterations to this equipment will void the warranty and may cause a dangerous condition. This appliance is not intended to be operated by means of an external timer or separate remote-control system. NEVER make alterations to this equipment. Read the Installation, Operating, and Maintenance Instructions thoroughly before installing, servicing, or operating this equipment.</p> <p style="text-align: right; font-size: small;">014_020416</p>



	 <b>WARNING</b>
	<p>To avoid burns, DO NOT touch the kettle or any heated surface. DO NOT place or leave objects in contact with heated surfaces.</p> <p style="text-align: right; font-size: small;">013_092414</p>



	 <b>WARNING</b>
	<p>ALWAYS wear safety glasses when servicing this equipment.</p> <p style="text-align: right; font-size: small;">010_010914</p>

	 <b>WARNING</b>
	<p>No user serviceable parts inside. Refer servicing to qualified service personnel.</p> <p style="text-align: right; font-size: small;">011_051514</p>

	 <b>WARNING</b>
	<p>Read and understand operator's manual and all other safety instructions before using this equipment. To order copies of the operator's manual go to <a href="http://gmpopcorn.com">gmpopcorn.com</a> or write to Gold Medal Products Co., 10700 Medallion Drive, Cincinnati, OH 45241 USA 1-(800)-543-0862</p> <p style="text-align: right; font-size: small;">022_060215</p>

## SAFETY PRECAUTIONS (continued)

	 <b>WARNING</b>
	<p>DO NOT allow direct contact of this equipment by the public when used in food service locations. Only personnel trained and experienced in the equipment operation may operate this equipment. Carefully read all instructions before operation.</p> <p style="text-align: right;">012_010914</p>

	 <b>WARNING</b>
	<p>This machine is NOT to be operated by minors.</p> <p style="text-align: right;">007_010914</p>

This appliance is not intended for use by persons (including children) with reduced physical, sensory or mental capabilities, or lack of experience and knowledge, unless they have been given supervision or instruction concerning use of the appliance by a person responsible for their safety.

**Note:** Improvements are always being made to Gold Medal's equipment. This information may not be the latest available for your purposes. It is critical that you call Gold Medal's Technical Service Department at 1-800-543-0862 for any questions about your machine operations, replacement parts, or any service questions. (Gold Medal Products Co. does not assume any liability for injury due to careless handling and/or reckless operation of this equipment.) General images may be used in manual for reference only.



# INSTALLATION INSTRUCTIONS

## Inspection of Shipment

After unpacking, check thoroughly for any damage which may have occurred in transit. Claims should be filed immediately with the transportation company. The warranty does not cover damage that occurs in transit, or damage caused by abuse, or consequential damage due to the operation of this machine, since it is beyond our control (reference warranty in back of manual).

## Manual

Read and understand the operator's manual and all other safety instructions before using this equipment. To order copies of the operator's manual go to [gmpopcorn.com](http://gmpopcorn.com) or write to Gold Medal Products Co., 10700 Medallion Drive, Cincinnati, OH 45241 USA 1-(800)-543-0862.

## Model Description

**2626:** Karmel Baby, 2.5 Gallon Cooker/Mixer

**2626EX:** Export Karmel Baby, 2.5 Gallon Cooker/Mixer

This appliance is intended to be used in household and similar applications such as staff kitchen areas in shops, offices and other working environments; farm houses; by clients in hotels, motels, bed and breakfast or other residential type environments.

## Items Included with this Unit



**2 Cup Measure**



**Aluminum Scoop**



**2.5 Gallon Bucket**



**Bowl Scraper**



## Setup

1. Remove all packaging and tape before starting operation.
2. This unit must be properly fastened to a sturdy counter.
3. Prior to operation, rotate the top paddle into the mixing position and fix into place with the wing bolt provided (see illustration below).
4. After setup, the unit should be cleaned prior to use (see Care and Cleaning section of this manual).

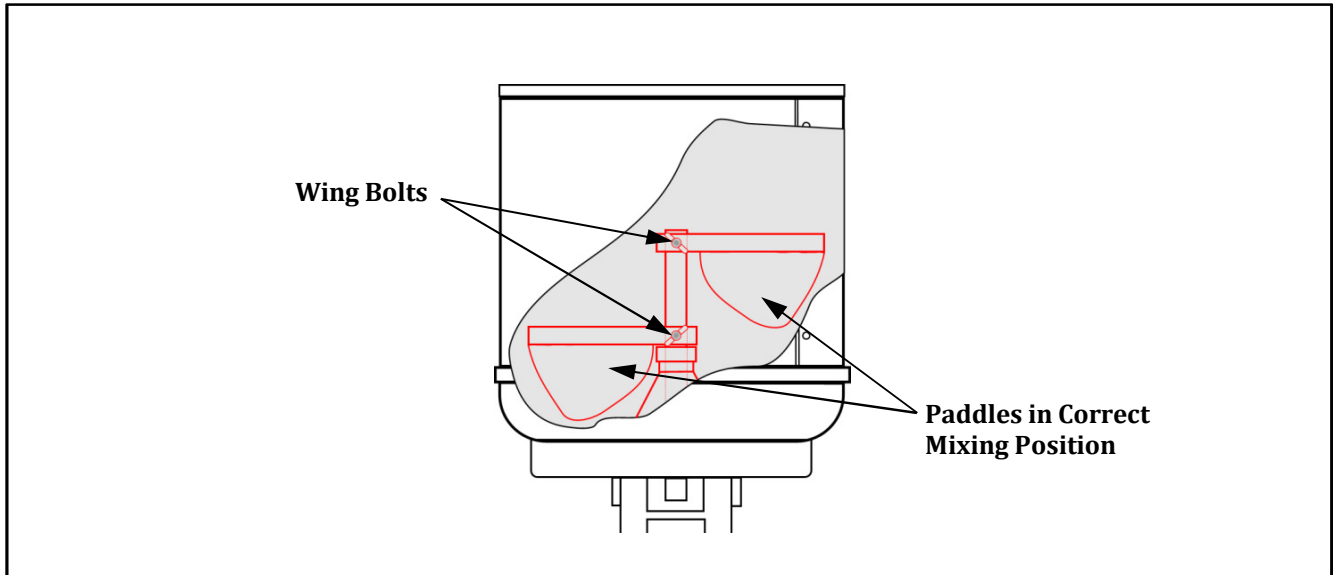





## Electrical Requirements

The following power supply must be provided:

**2626:** 120 Volts, 1720 Watts, 60 Hertz.



**2626EX:** 230 Volts, 1720 Watts, 50 Hertz

	 <b>DANGER</b>
	<p>Machine must be properly grounded to prevent electrical shock to personnel. Failure to do so could result in serious injury, or death.  <b>DO NOT</b> immerse any part of this equipment in water.  <b>DO NOT</b> use excessive water when cleaning.          Keep cord and plug off the ground and away from moisture.          Always unplug the equipment before cleaning or servicing.          Make sure all machine switches are in the OFF position before plugging the equipment into the receptacle.</p> <p style="text-align: right; font-size: small;">008_051514</p>

A certified electrician must furnish sufficient power for proper machine operation and install any supplied receptacle. We recommend this equipment be on a dedicated and protected circuit. Failure to wire properly will void the warranty and may result in damage to the machine. It is Gold Medal Products Co.'s recommendation that this machine be plugged directly into a wall outlet. The use of extension cords is not recommended due to safety concerns, and may cause sacrificed and/or reduced performance. Make sure cord is located to prevent a trip hazard or unit upset.

## Before You Plug In Machine

1. Make sure all machine switches are in the OFF position before plugging the equipment into the receptacle.
2. Make sure the wall outlet can accept the grounded plugs (where applicable) on the power supply cord.
3. The wall outlet must have the proper polarity. If in doubt, have a competent electrician inspect the outlet and correct if necessary.
4. **DO NOT** use a grounded to un-grounded receptacle adapter (where applicable).
5. Install the unit in a level position.

	 <b>CAUTION</b>
	<p>If the supply cord is damaged, it must be replaced by Gold Medal Products Co., its service agent or similarly qualified persons in order to avoid a hazard.</p> <p style="text-align: right; font-size: small;">039_080614</p>



---

# OPERATING INSTRUCTIONS

## Controls and Their Functions

### HEAT/MOTOR SWITCH

This rocker switch in the “ON” position energizes the heating elements in the bottom of the kettle, and the motor will also turn for 30 seconds of every minute.

**Note:** It is normal for the motor to stop for 30 seconds of every minute (when the Motor Only Switch is OFF).

### MOTOR SWITCH

With this rocker switch in the “ON” position, the agitator motor will run continuously.

**Note:** The main function of this switch is for mixing the product/popcorn at the end of the cooking cycle with the kettle in the tilt position, and it is used for “cleaning mode”.

### HEAT CONTROL

The machine comes from the factory preset for a “Product Cook Temperature” of 280°F for Corn Treat machines. If more or less heat is required, remove the silver hole plug located on the front panel of the control box. This will allow you to access the heat control adjustment potentiometer. Turn the potentiometer slightly clockwise to increase the temperature, and counter-clockwise to decrease the temperature.

**To Calibrate the Heat Control for a 280°F “Product Cook Temperature”:** Fill the mixing bowl with a one inch depth of corn oil. Use an accurate thermometer to measure the temperature of the oil in the mixing bowl. Stir the oil while it heats. When the oil reaches 310°F slowly turn the potentiometer counter clockwise until the buzzer sounds. If the buzzer sounds before the temperature reaches 310°F turn the potentiometer clockwise until the buzzer stops and continue to turn an additional 1/8 turn.

**Note:** The sound of the buzzer signals kettle heat shut-off.

### Kettle Dump Handle

This lever tilts the kettle from the upright cook position to the mix position or the dump position.

### Kettle Stop Lever

This lever stops the kettle in the mix position or in the dump position.

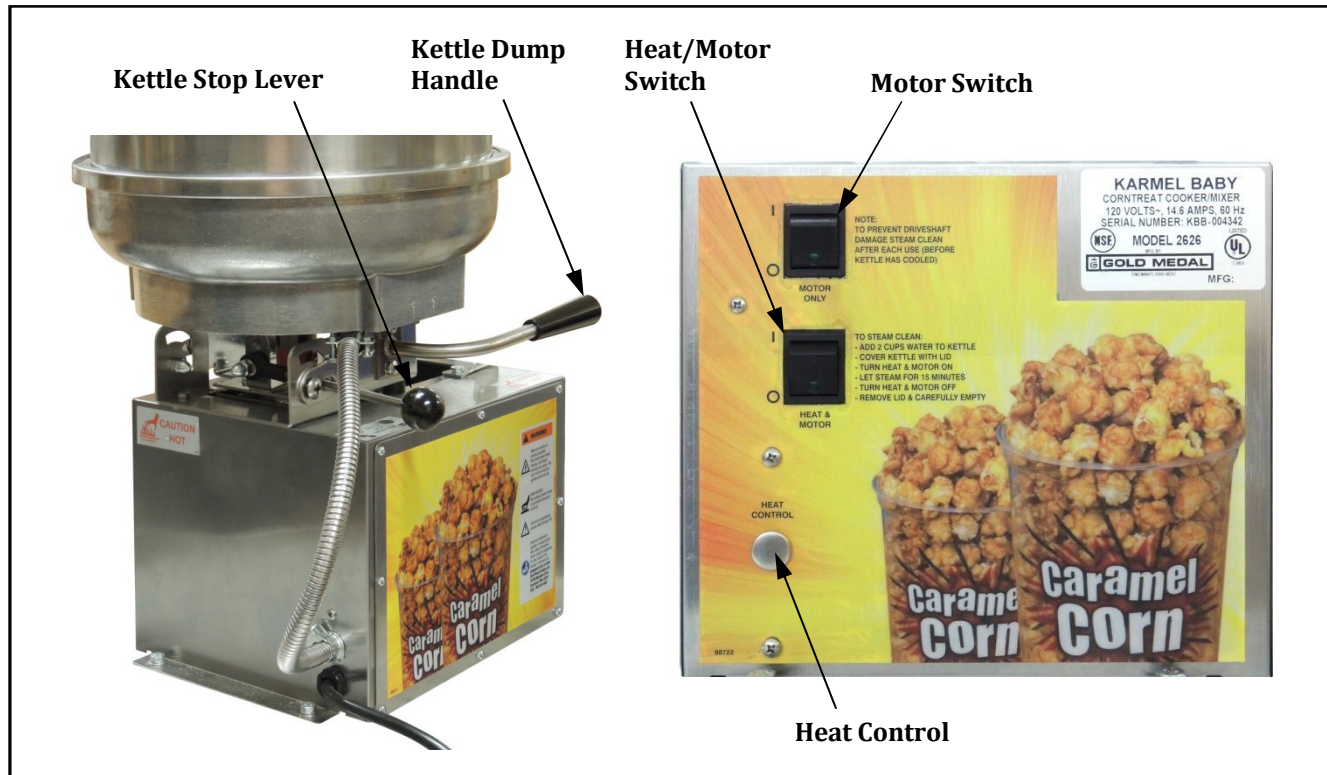

## Instructions for Making Carmel Corn

1. Always remember to leave the lid on the kettle during the first part of the batch. Once steam starts to “roll-up” from underneath the lid, then carefully remove the lid for the remainder of the cooking cycle.
2. Turn the Heat/Motor switch ON (do not turn on the Motor switch).
3. Add 6 oz. of water and one package of Gold Medal 2157 2.5 gal Caramel Complete Mix.
4. Turn the Motor switch ON and mix for approximately one minute. Turn the Motor switch OFF. (With the Heat/Motor switch ON, the motor will run for 30 seconds every minute.)
5. Allow the mix to cook until the buzzer sounds at 280°F product temperature.
6. Turn the Heat/Motor switch OFF.
7. Turn the Motor switch ON.
8. Add two and a half gallons of pre-popped corn.
9. Allow the corn to mix for approximately ten (10) seconds with the kettle in the upright position.
10. Move the kettle to the mix position and mix the popcorn until it is thoroughly coated.
11. Dump the caramel corn into the cooling pan.
12. After dumping caramel corn, turn Motor switch OFF.





## Care and Cleaning

	<b>⚠ DANGER</b>
	<p>Machine must be properly grounded to prevent electrical shock to personnel. <b>DO NOT immerse in water.</b> DO NOT clean appliance with a water jet. Always unplug the equipment before cleaning or servicing.</p> <p style="text-align: right;">025_111616</p>

	<b>⚠ WARNING</b>
	<p>To avoid serious burns, DO NOT touch the kettle while it is hot!</p> <p style="text-align: right;">028_020314</p>

Good sanitation practice demands that all food preparation equipment be cleaned regularly (only use non-toxic, food grade cleaners). A clean looking, well-kept machine is one of the best ways of advertising your product.

### Corn Treat Cleaning Instructions

**Note:** It is extremely important to follow all of the cleaning procedures, otherwise parts damage and equipment failure will result. The warranty does not cover parts that are damaged due to improper cleaning.

### Proper Kettle Cleaning Procedure

Follow the procedure below to steam the sugar build-up out of the kettle every 3-4 batches during regular operation and before the machine is turned off for the day. The kettle must also be steamed out after making single batches, if the machine is turned off between batches.

1. After all product has been removed, and the kettle has cooled for 15-20 minutes, carefully pour 24 oz. of water into the kettle.

**CAUTION: Beware of rising steam; make sure to keep face and hands clear of the rising steam.**

2. Place the lid on the kettle, and turn the Heat/Motor Switch ON.
3. When water starts to boil, turn Heat/Motor Switch OFF.
4. Turn the Motor Switch ON; allow the machine to cool, then remove the lid and carefully pour the contents of the kettle into a pan or bucket. Steam the kettle twice to remove all traces of product.
5. Turn the Motor Switch OFF.
6. With all switches OFF, wipe out any excess sugar build-up from the kettle using a damp rag, then the kettle is ready to begin another batch.
7. Do not leave water in the pans overnight.



## Daily Unit Cleaning Procedure

Follow the directions below to clean and sanitize the unit each day after use.

1. With the machine OFF, unplug the unit and allow it to cool before attempting to clean.
2. Make sure to clean all pans/accessories in order to sanitize them before each use.
3. Release the draw latch to easily remove the mixing drum, then remove paddles. The mixing drum and paddles can be taken to the sink to clean.
4. Wipe the kettle lead cord with a clean **SLIGHTLY** damp cloth. **DO NOT get moisture into the kettle lead-in cord, severe damage will result.**
5. The cabinet of your machine should be wiped clean daily (or more, depending on usage) with a clean soft cloth, SLIGHTLY dampened with soap and hot water.
6. Wipe the stainless steel parts with a clean cloth and cleaner designed for stainless steel, such as Gold Medal Watchdog Stainless Cleaner (Item No. 2088).

**DO NOT** use oven cleaners or abrasive materials as they will damage parts of the machine.

## Proper Hub Seal Assembly Cleaning Procedure

**Important:** For proper machine performance, keep the hub seal and o-rings clean.



Follow the steps below weekly to ensure proper machine performance:

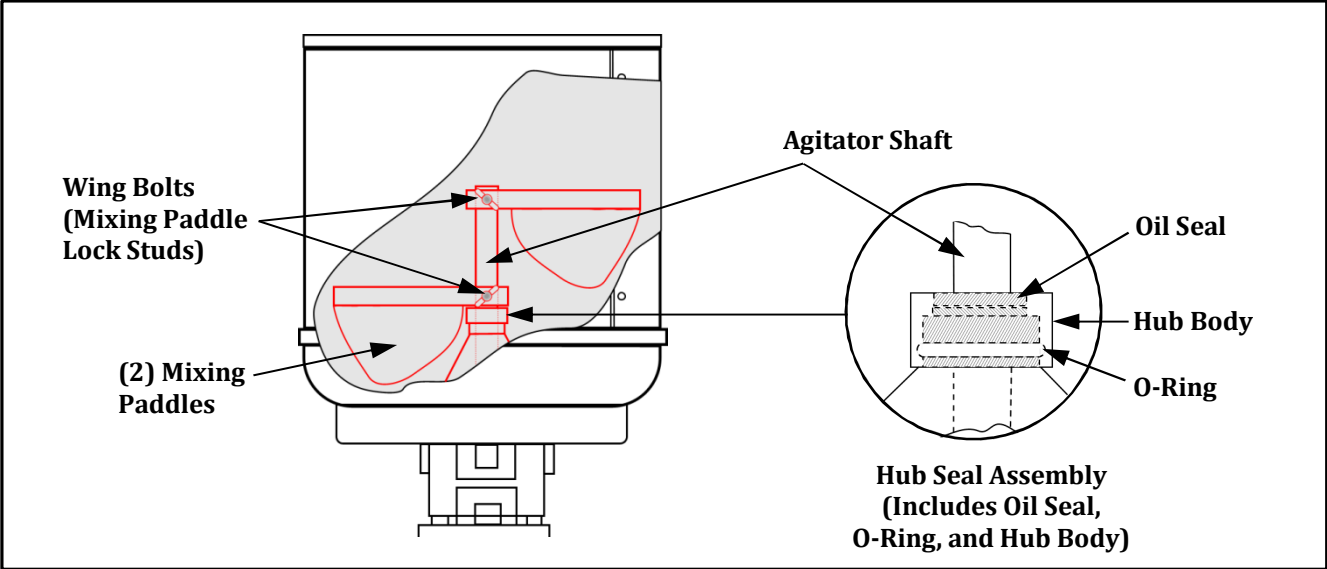

1. With the machine OFF, unplug the unit from the power source and allow it to cool before attempting to clean the Hub Seal Assembly.
2. Loosen the wing bolts (Mixing Paddle Lock Studs) and remove the mix paddles.
3. Remove any burrs on the shaft using a fine grit emery paper to lightly sand the surface. If the burrs are not removed, damage may occur to the o-ring/oil seal during removal/installation.
4. Remove the hub seal assembly and soak it in hot water to clean.
5. Clean the area around the center hub. Remove any product residue. (See Kettle Shaft Maintenance for note on lubricating the kettle bushings.)
6. Lightly lubricate the center hub of the kettle with a small amount of vegetable oil to allow for easy installation of the hub seal assembly.
7. Slide the clean hub seal assembly down the agitator shaft. Apply pressure to ease the assembly over the center hub of the kettle until it seats properly (see diagram shown.)
8. After the hub seal assembly has been properly installed, re-install the mix paddles onto the agitator shaft.
9. Finger tighten the wing bolts to secure the mixing paddles in place.









# MAINTENANCE INSTRUCTIONS

	 <b>DANGER</b>
	<p>Machine must be properly grounded to prevent electrical shock to personnel. Failure to do so could result in serious injury, or death.  <b>DO NOT</b> immerse any part of this equipment in water.  <b>DO NOT</b> use excessive water when cleaning.          Keep cord and plug off the ground and away from moisture.          Always unplug the equipment before cleaning or servicing.          Make sure all machine switches are in the OFF position before plugging the equipment into the receptacle.</p> <p style="text-align: right;">008_051514</p>

	 <b>DANGER</b>
	<p>Improper installation, adjustment, alteration, service, or maintenance can cause property damage, injury, or death. Any alterations to this equipment will void the warranty and may cause a dangerous condition. This appliance is not intended to be operated by means of an external timer or separate remote-control system. <b>NEVER</b> make alterations to this equipment. Read the Installation, Operating, and Maintenance Instructions thoroughly before installing, servicing, or operating this equipment.</p> <p style="text-align: right;">014_020416</p>

	 <b>WARNING</b>
	<p>No user serviceable parts inside. Refer servicing to qualified service personnel.</p> <p style="text-align: right;">011_051514</p>

	 <b>CAUTION</b>
	<p>THE FOLLOWING SECTIONS OF THIS MANUAL ARE INTENDED ONLY FOR QUALIFIED SERVICE PERSONNEL WHO ARE FAMILIAR WITH ELECTRICAL EQUIPMENT. THESE ARE NOT INTENDED FOR THE OPERATOR.</p> <p style="text-align: right;">027_010914</p>



# New Paddle / Hub Seal Kit Installation

## Kettle Shaft Maintenance

1. With the machine OFF, unplug the unit from the power source and allow it to cool.
2. Loosen the wing bolts (Mixing Paddle Lock Studs) and remove the mix paddles.
3. Remove the old hub seal assembly.
4. Clean the area around the center hub. Remove any product residue.

**Note:** The kettle shaft should be removed monthly and the bushings lubricated with Never Seez® (use White Food Grade **ONLY**). To do this, loosen the set screw in the Jaw Coupling and remove the shaft. **DO NOT lose the shaft key; this must be reset into place when reassembling.**

5. Remove any burrs on the shaft using a fine grit emery paper to lightly sand the surface. If the burrs are not removed, damage may occur to the new o-ring/oil seal during installation.
6. Lightly lubricate the center hub of the kettle with a small amount of vegetable oil to allow for easy installation of the hub seal assembly.
7. Slide the new hub seal assembly down the agitator shaft. Apply pressure to ease the assembly over the center hub of the kettle until it seats properly (see diagram below.)
8. After the hub seal assembly has been properly installed, re-install the mix paddles onto the agitator shaft.
9. Finger tighten the wing bolts to secure the mixing paddles in place.

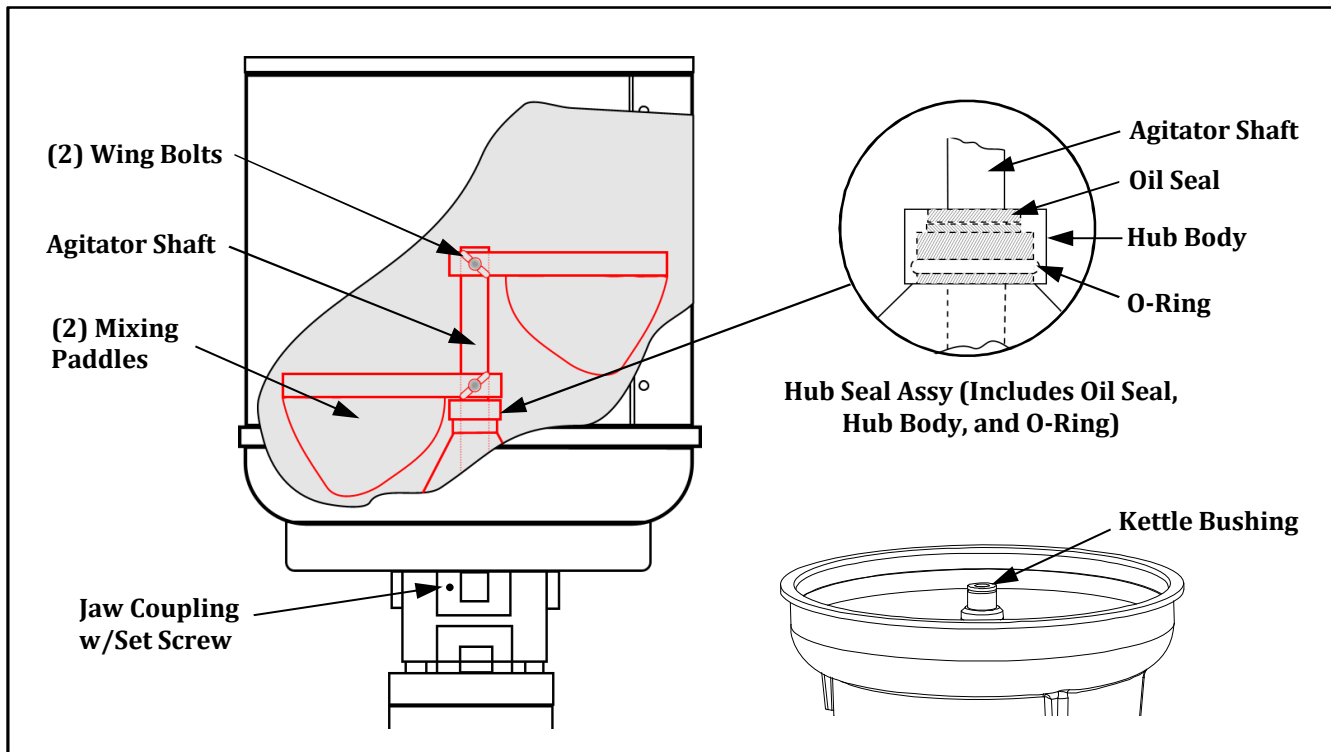



---

## ORDERING SPARE PARTS

1. Identify the needed part by checking it against the photos, illustrations, and/or parts list. (General images may be used in manual for reference only.)
2. Use only approved replacement parts when servicing this unit.
3. When ordering, please include part number, part name, and quantity needed.
4. Please include your model number, serial number, and date of manufacture (located on the machine nameplate/data plate) with your order.
5. Address all parts orders to:

Parts Department  
Gold Medal Products Co.  
10700 Medallion Drive  
Cincinnati, Ohio 45241-4807

Or, place orders by phone or online:

Phone: (800) 543-0862  
(513) 769-7676  
Fax: (800) 542-1496  
(513) 769-8500  
E-mail: [info@gmpopcorn.com](mailto:info@gmpopcorn.com)  
Web Page: [gmpopcorn.com](http://gmpopcorn.com)

# Model 2626 (Domestic) – Unit Exterior – Parts Breakdown

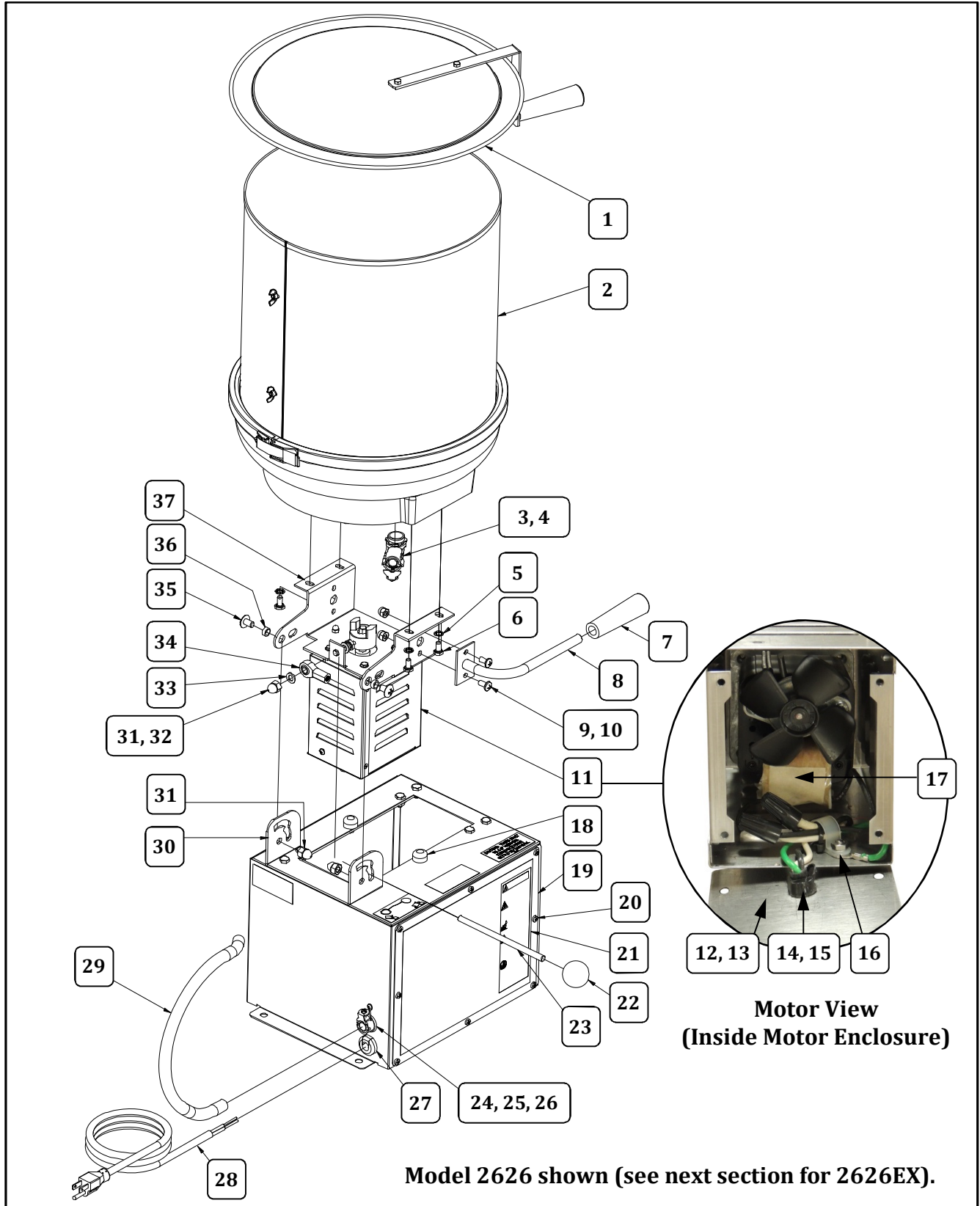



## Model 2626 (Domestic) – Unit Exterior – Parts List

Item	Part Description	Part Number
		2626
1	LID ASSEMBLY (includes handle)	16810
2	KETTLE SUBASSEMBLY (see Kettle Assembly Breakdown section for itemized parts list)	111026
3	CONNECTOR 90 DEGREE (see Kettle Lead -In Parts Breakdown section for Kettle Lead Wire Assembly)	46241
4	1/2 CONDUIT BUSHING NM	82135NM
5	WASHER 1/4 INTERNAL TOOTH	12383
6	1/4-20 X 1/2 HX HD SCREW	12382
7	PLASTIC DUMP HANDLE	41139
8	HANDLE WELDMENT	88732
9	1/4-20 X 1/2 P/H PHIL	12471
10	1/4-20 ACORN NUT	42229
11	MOTOR ENCLOSURE	88740
12	MOTOR COVER END PLATE	88739
13	SCREW #8-32X3/8 PAN HD PH	74141
14	STRAIN RELIEF #SR-10-2	87163
15	MOTOR LEAD IN CORD ASSEMBLY	111034
16	CABLE CLAMP	87219
17	KETTLE DRIVE MOTOR 120V	88744
18	RUBBER BUMPER	87247
19	FACE PLATE	16925
20	8-32 X 1/2 PH PAN T/S (Front Plate Screws)	87245
21	FRONT DECAL 2626	88721
22	1-3/8" BALL KNOB	111033
23	STOP HANDLE	111005
24	CONNECTOR CONDUIT FLEX (straight 3/8 with screws)	41252
25	1/2" CONDUIT BUSHING	41253NM
26	BRASS SHIM	82262
27	STRAIN RELIEF SR7W-2	67060
28	LEAD-IN CORD 15 AMP PLUG	87085
29	FLEXIBLE CONDUIT	82252-19
30	PIVOT BRACKET	111012
31	HI CROWN ACORN - ZINC	77610
32	5/16-18 X 1 HEX C/S 18-8 (Cap Screw)	12489
33	PLAIN WASHER, STAINLESS	77865
34	NYLON ROD END	111032
35	5/16-18 X 1/2 PH TR M/S	12183
36	SPACER .438ODx.323IDx.180	88741
37	MOTOR MOUNT	111004





# Model 2626EX (Export) – Unit Exterior – Parts Breakdown

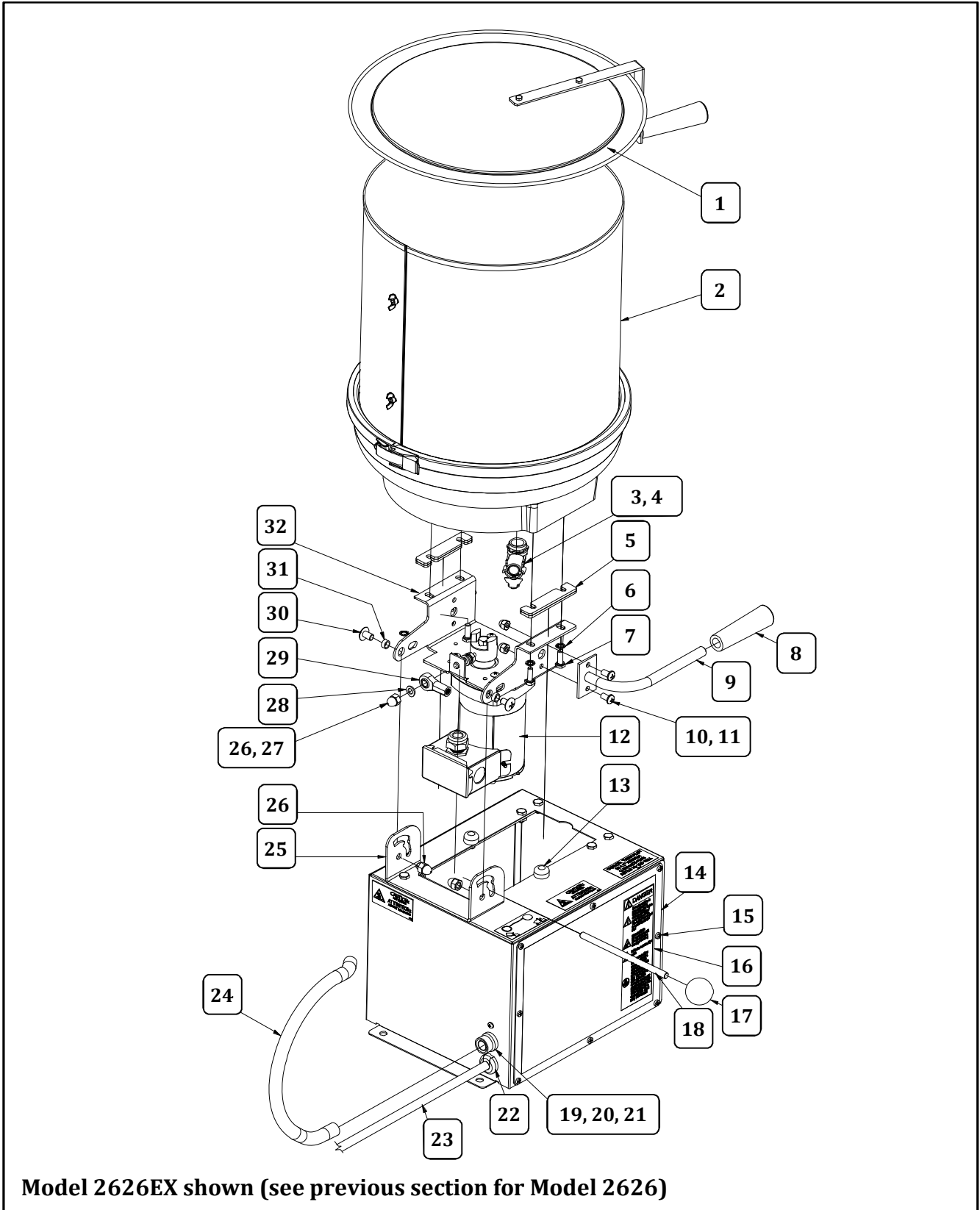

Model 2626EX shown (see previous section for Model 2626)



## Model 2626EX (Export) – Unit Exterior – Parts List

Item	Part Description	Part Number
		2626EX
1	LID ASSEMBLY (includes handle)	16810
2	KETTLE SUBASSEMBLY (see Kettle Assembly Breakdown section for itemized parts list)	111026EX
3	CONNECTOR 90 DEGREE (see Kettle Lead -In Parts Breakdown section for Kettle Lead Wire Assembly)	46241
4	1/2 CONDUIT BUSHING NM	82135NM
5	MOTOR MOUNT SPACER (4 required)	114000
6	WASHER 1/4 INTERNAL TOOTH	12383
7	1/4-20 X 3/4 HEX CAP 18-8	12515
8	PLASTIC DUMP HANDLE	41139
9	HANDLE WELDMENT	88732
10	1/4-20 X 1/2 P/H PHIL	12471
11	1/4-20 ACORN NUT	42229
12	KETTLE DRIVE MOTOR 230V	16723EX
13	RUBBER BUMPER	87247
14	FACE PLATE	16925
15	8-32 X 1/2 PH PAN T/S (Front Plate Screws)	87245
16	FRONT DECAL 2626	88721
17	1-3/8" BALL KNOB	111033
18	STOP HANDLE	111005
19	CONNECTOR CONDUIT FLEX (straight 3/8 with screws)	41252
20	1/2" CONDUIT BUSHING	41253NM
21	BRASS SHIM	82262
22	STRAIN RELIEF SR7W-2	67060
23	POWER SUPPLY CORD, EXPORT	42369
24	FLEXIBLE CONDUIT	82252-19
25	PIVOT BRACKET	111012
26	HI CROWN ACORN - ZINC	77610
27	5/16-18 X 1 HEX C/S 18-8 (Cap Screw)	12489
28	PLAIN WASHER, STAINLESS	77865
29	NYLON ROD END	111032
30	5/16-18 X 1/2 PH TR M/S	12183
31	SPACER .438ODx.323IDx.180	88741
32	MOTOR MOUNT	111004



# Kettle Assembly Breakdown

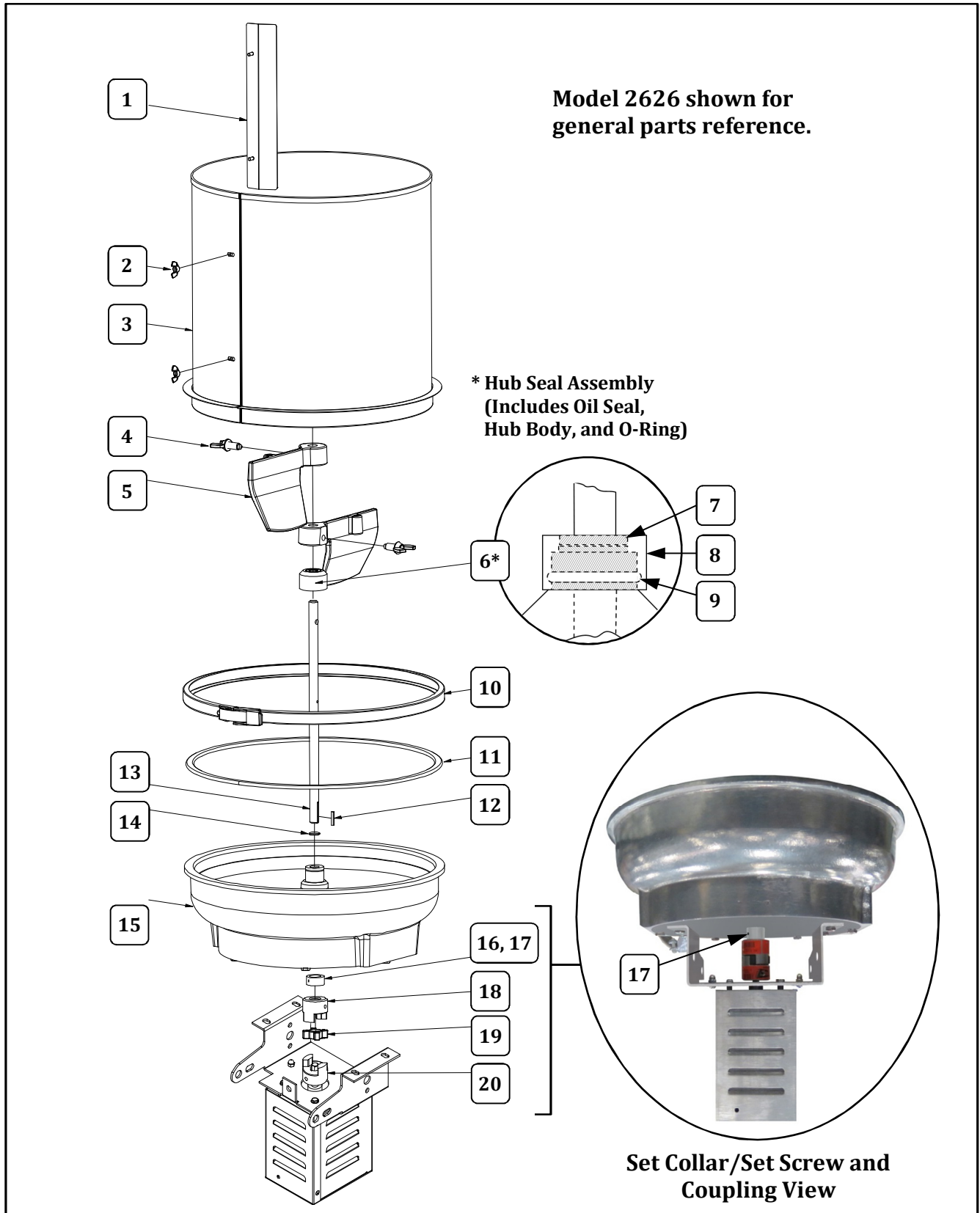



## Kettle Assembly Breakdown – Parts List

Item	Part Description	Part Number	
		2626	2626EX
1	BLENDING STRIP MARK 2.5	16765	16765
2	WING NUT, #8-32	89126	89126
3	MIXING DRUM MARK 2.5	16761	16761
4	MIX PADDLE LOCK STUD ASSY	16767	16767
5	MIX PADDLE MK 2.5	88743	88743
6	HUB SEAL ASSEMBLY	16752	16752
7	HUB SEAL (Oil Seal)	16748	16748
8	SEAL BODY (Hub Body)	16734	16734
9	SEAL O-RING	16749	16749
10	RETAINING RING ASSY	16762	16762
11	DRUM SEAL	16764	16764
12	MACHINE KEY	16808	16808
13	DRIVE SHAFT	16732	16732
14	DRIVE SHAFT O-RING	16747	16747
15	MARK 2.5 KETTLE ASSEMBLY (for itemized parts list see Kettle Bottom Parts Breakdown section)	88730	88730EX
16	½ ID X 7/8 OD SET COLLAR	47326	47326
17	¼-20 X ¼ SET SCREW	46610	46610
18	JAW COUPLING BODY 1/2IN B	88729	88729
19	JAW COUPLING SPIDER	88727	88727
20	JAW COUPLING 3/8"	88728	
	JAW COUPLING BODY 1/2IN B		88729



## Kettle Lead-In / Kettle Bottom Breakdown

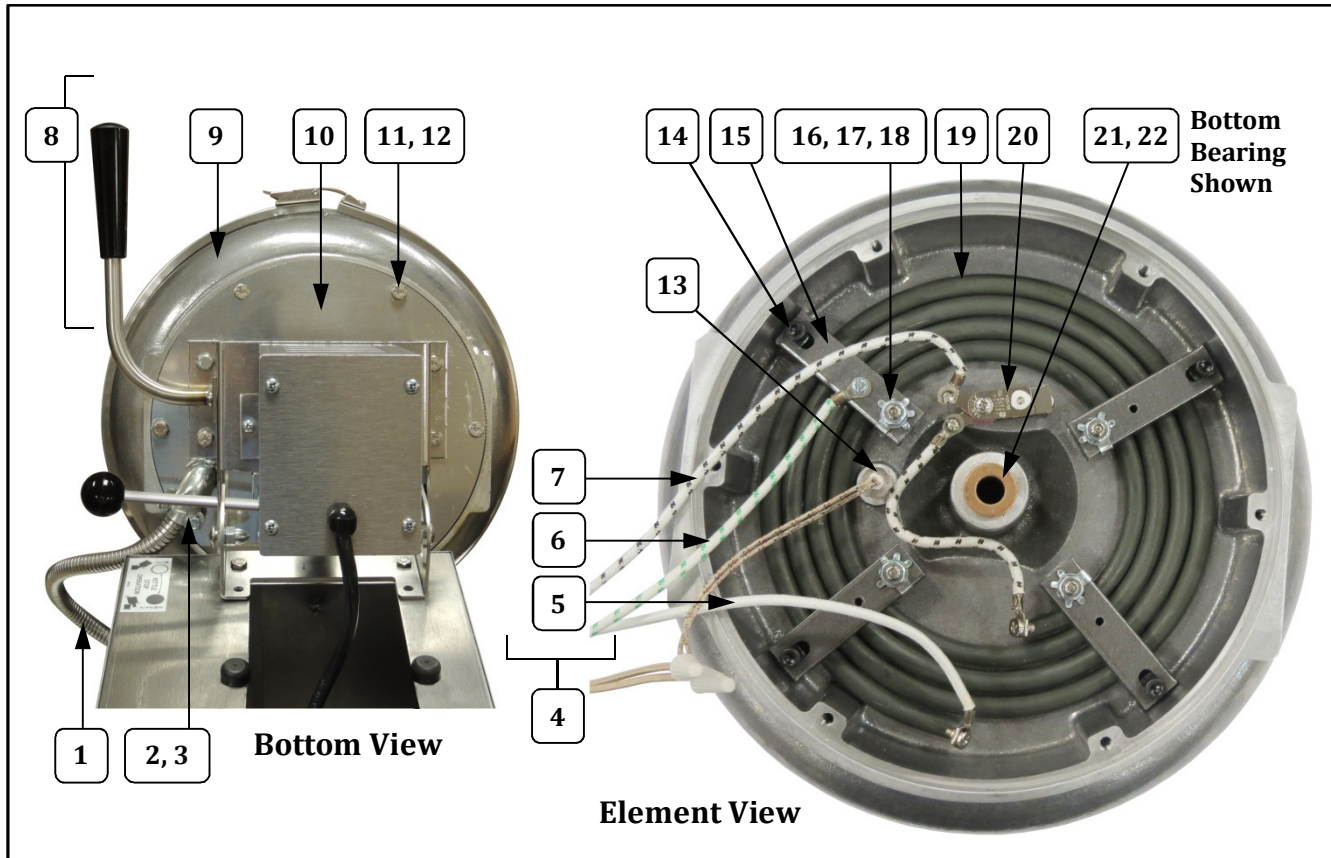

Item	Part Description	Qty.	Part Number	
			2626	2626EX
1	FLEXIBLE CONDUIT	1	82107-19	87107-19
2	CONNECTOR 90 DEGREE	1	46241	46241
3	1/2 CONDUIT BUSHING NM	1	82135NM	82135NM
4	KETTLE LEAD ASSY (inclds. wire items 5-7 below)	1	55546	55546
5	12GA MGT WHT 37IN	1	MW12U37E	MW12U37E
6	12GA MGT GRN 30IN	1	MG12I30U	MG12I30U
7	12GA MGT BLK 40IN	1	MB12E40U	MB12E40U
8	KETTLE SUB ASSEMBLY (includes parts below)	1	88730	88730EX
9	MARK 2.5 KETTLE ASSEMBLY	1	16766	16766
10	BOTTOM PLATE	1	111013	111013
11	1/4-20 X 1/2 HX HD SCREW	6	12382	12382
12	WASHER 1/4 INTERNAL TOOTH	6	12383	12383
13	RTD HEAT SENSOR	1	46299	46299
14	1/4-20 X 1/2 Socket Head Screw	4	46722	46722
15	ELEMENT CLAMP 16/18OZ	4	67894	67894
16	1/4-20 x 1.25 SET SCREW	4	59060	59060
17	NUT RETAINER	4	50190	50190
18	HEX NUT 1/4-20	4	74133	74133
19	TUBULAR HEAT ELEMENT 1720	1	67889	67889EX
20	THERMOSTAT 525F	1	76702	76702
21	FLANGE BEARING MARK 2.5 (bottom Bearing)	1	16735PMO	16735PMO
22	FLANGE BEARING MACHINED (top bearing)	1	16735	16735

## Controls and Control Box Interior View

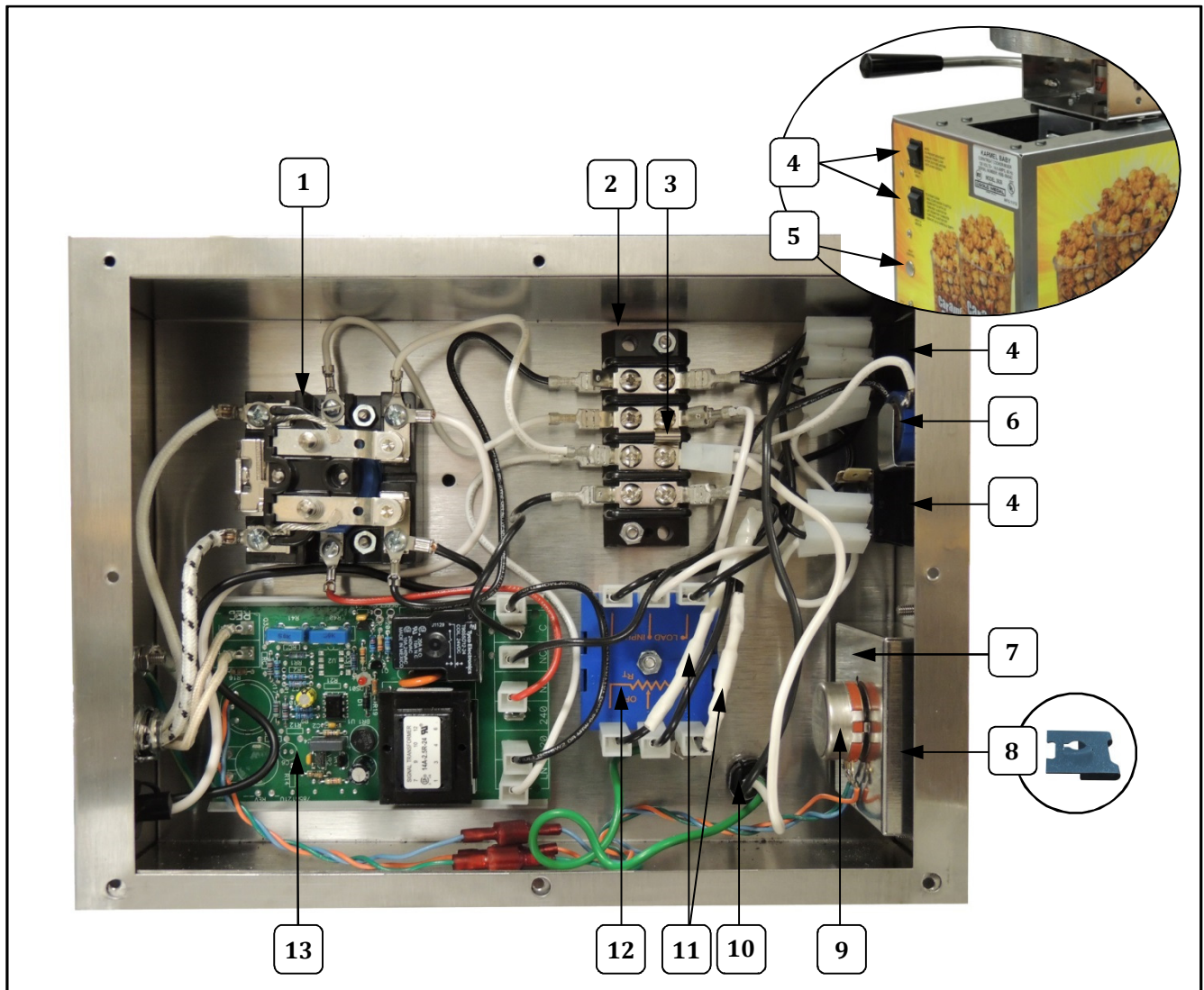

Item	Part Description	Qty.	Part Number	
			2626	2626EX
1	RELAY, 30A DPST 120V	1	55219	55219EX
2	TERMINAL BLOCK	1	42006	42006
3	JUMPER	1	61100	61100
4	SWITCH, ROCKER DPDT LGHT	2	48616	48616
5	HOLE PLUG, 1/2 DIA. SS	1	45395	45395
6	BUZZER SIGNAL	1	46118	46120
7	POTENTIOMETER ENCLOSURE	1	55120	55120
8	8-32 TINNEMAN FASTENER	2	42222	42222
9	POTENTIOMETER, 500 OHM	1	46326	46326
10	STRAIN RELIEF #SR-6P3-4	1	76026	76026
11	RESISTOR, 500K 1 WATT	2	55009	55009
12	TIMER, PERCENTAGE 60 SEC	1	48688	48688EX
13	TEMPERATURE CONTROL, RTD	1	55057	55057



## Accessories

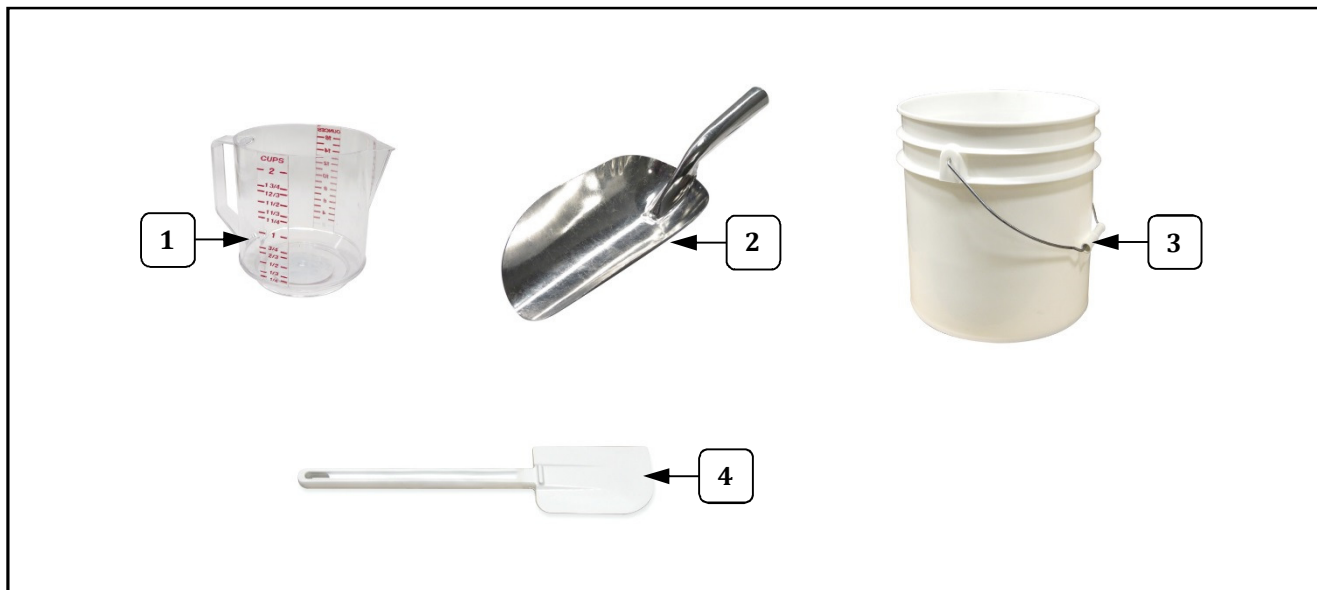

Item	Part Description	Part Number
1	2 CUP ACRYLIC MEASURE	62807
2	STAMPED ALUMINUM SCOOP	2071
3	2.5 GALLON BUCKET	16949
4	BOWL SCRAPER	46210



# WIRING DIAGRAM

## Model No. 2626

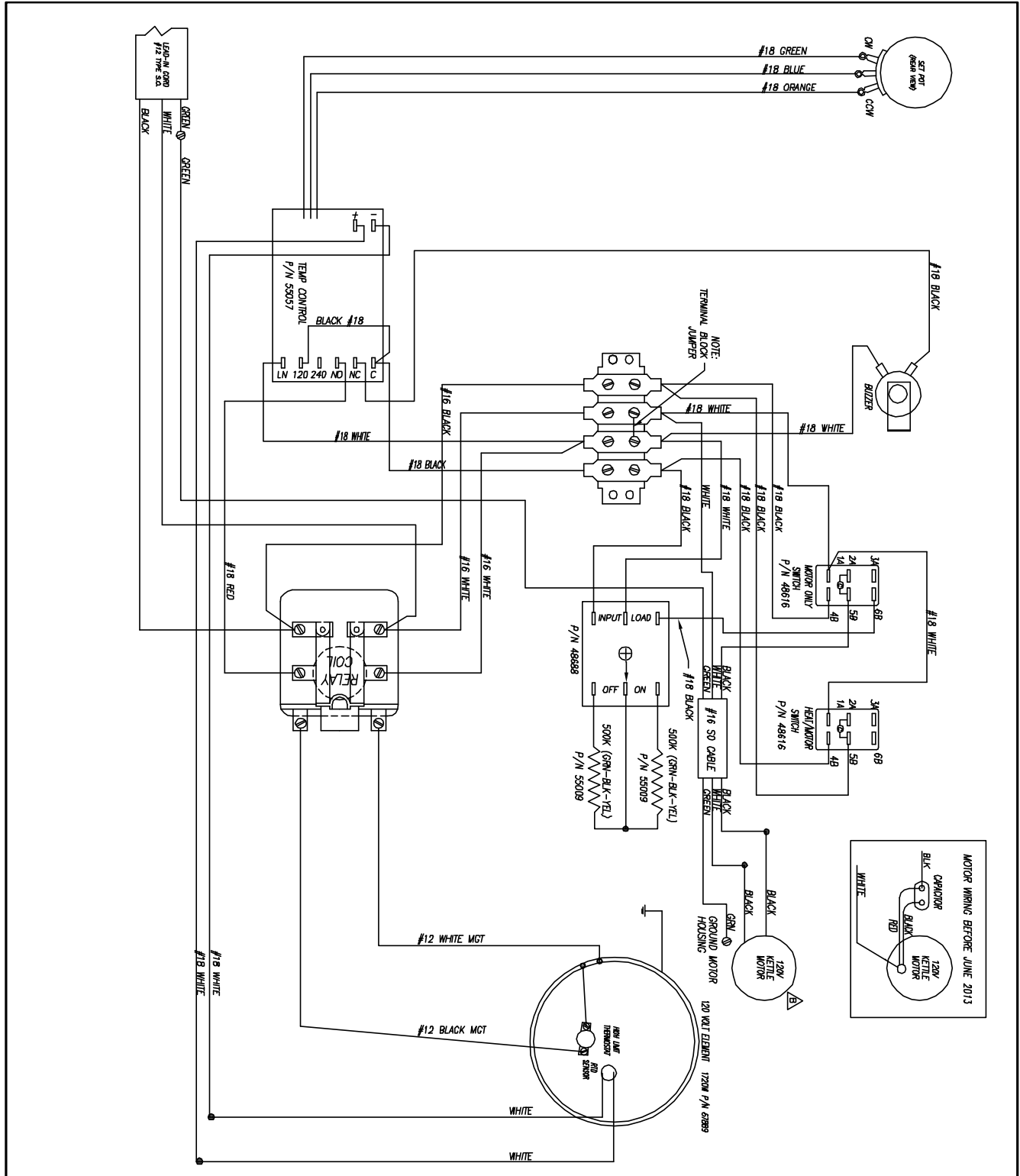





# Model No. 2626EX

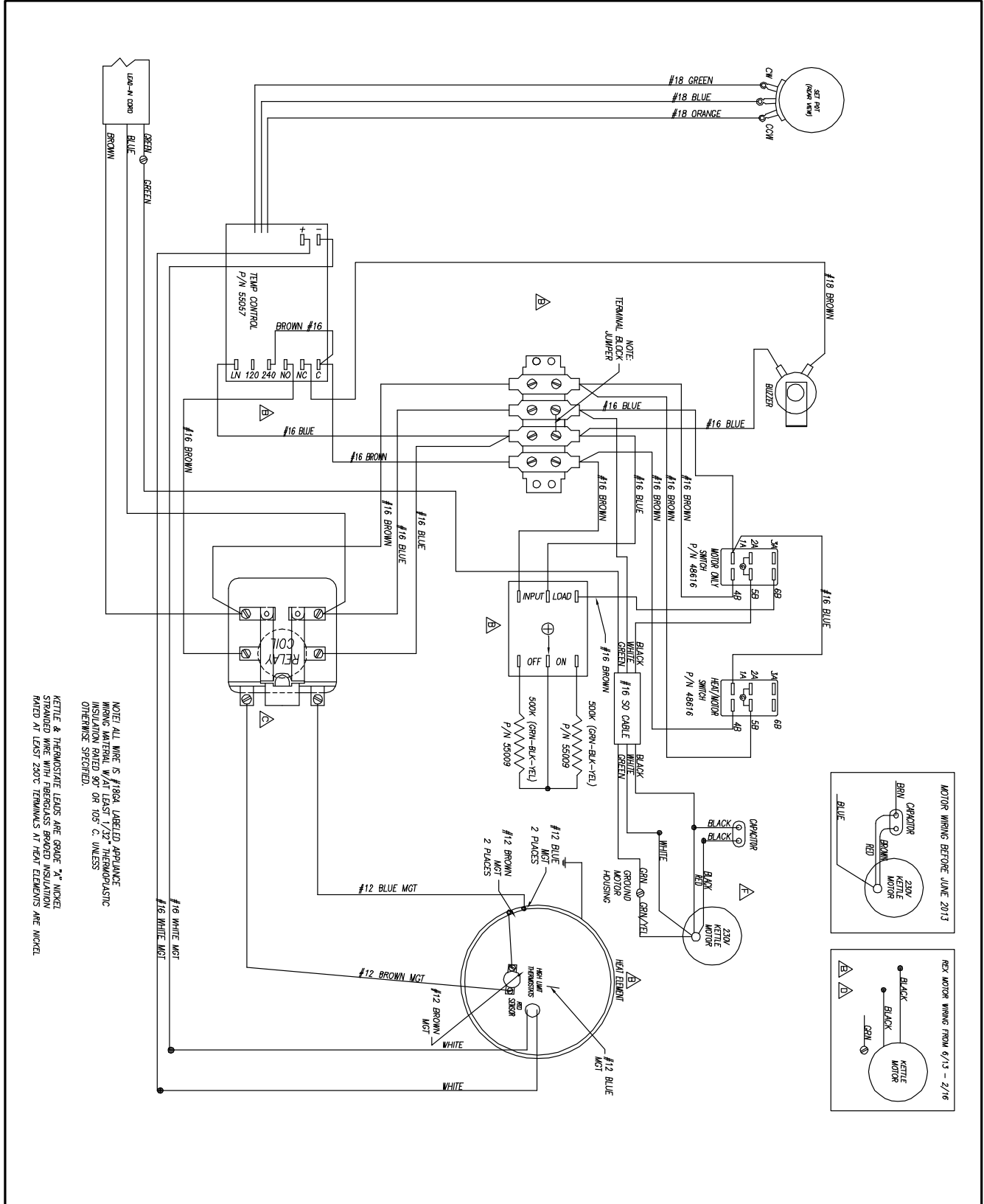



# WARRANTY

Gold Medal Products Co. warrants to the original purchaser each item of its manufacture to be free of defects in workmanship and material under normal use and service. Gold Medal Products Co.'s obligation under this warranty is limited solely to repairing or replacing parts, f.o.b. Cincinnati, Ohio, which in its judgment are defective in workmanship or material and which are returned, freight prepaid, to its Cincinnati, Ohio factory or other designated point. Except for "Perishable Parts" on specific machines, the above warranty applies for a period of two (2) years from the date of original sale to the original purchaser of equipment when recommended operating instructions and maintenance procedures have been followed. These are packed with the machine. Parts warranty is two (2) years, labor is six (6) months.

THIS WARRANTY IS IN LIEU OF ALL OTHER WARRANTIES EXPRESSED OR IMPLIED, AND OF ALL OTHER OBLIGATIONS OR LIABILITIES ON OUR PART, INCLUDING THE IMPLIED WARRANTY OF MERCHANTABILITY. THERE ARE NO WARRANTIES WHICH EXTEND BEYOND THE DESCRIPTION ON THE FACE HEREOF. In no event shall Gold Medal Products Co. be liable for special, incidental or consequential damages. No claim under this warranty will be honored if the equipment covered has been misused, neglected, damaged in transit, or has been tampered with or changed in any way. No claim under this warranty shall be honored in the event that components in the unit at the time of the claim were not supplied or approved by Gold Medal Products Co. This warranty is effective only when electrical items have been properly attached to city utility lines only at proper voltages. This warranty is not transferable without the written consent of Gold Medal Products Co.

The term "Original Purchaser" as used in this warranty shall be deemed to mean that person, firm, association, or corporation who was billed by the GOLD MEDAL PRODUCTS CO., or their authorized distributor for the equipment.

THIS WARRANTY HAS NO EFFECT AND IS VOID UNLESS THE ORIGINAL PURCHASER FIRST CALLS GOLD MEDAL PRODUCTS CO. AT 1-800-543-0862 TO DISCUSS WITH OUR SERVICE REPRESENTATIVE THE EQUIPMENT PROBLEM, AND, IF NECESSARY, FOR INSTRUCTIONS CONCERNING THE REPAIR OR REPLACEMENT OF PARTS.

*NOTE: This equipment is manufactured and sold for commercial use only.*



**GOLD MEDAL® PRODUCTS CO.**

10700 Medallion Drive, Cincinnati, Ohio 45241-4807 USA

[gmpopcorn.com](http://gmpopcorn.com)

Phone: (800) 543-0862      Fax: (800) 542-1496  
(513) 769-7676              (513) 769-8500

© 2017 – The text, descriptions, graphics, layout, and other material in this publication are the exclusive property of Gold Medal Products Co. and shall not be used, copied, reproduced, or published in any fashion, including website display, without its express written consent.